

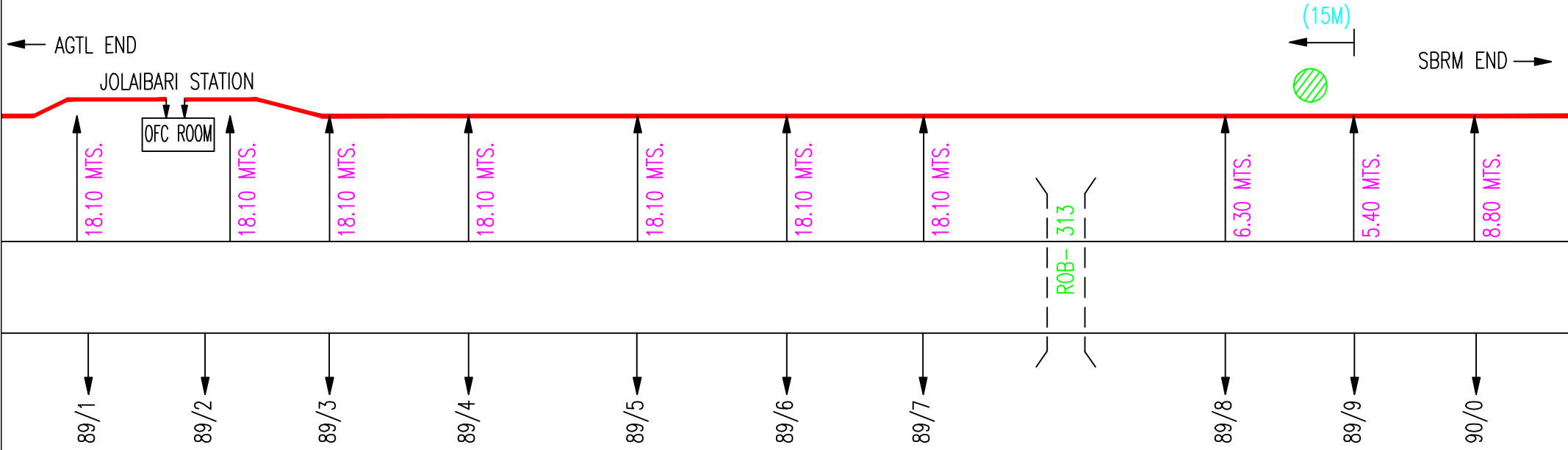



JOLAIBARI STATION



OFC JOINT → 

6 QUAD JOINT → 

EMARGENCY SOCKET POST → 

OFC CABLE  } SAME ROUTE

6 QUAD CABLE  }

JOLAIBARI STATION

← AGTL END

SBRM END →

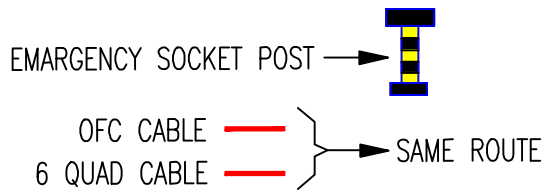
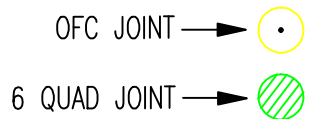
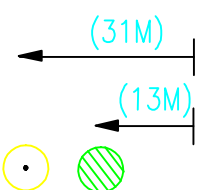
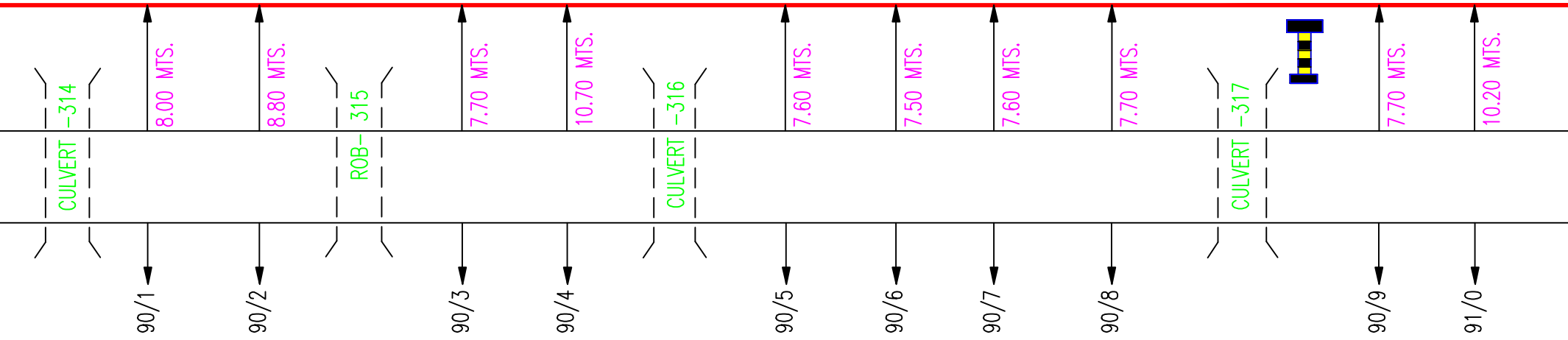

JOLAIBARI STATION

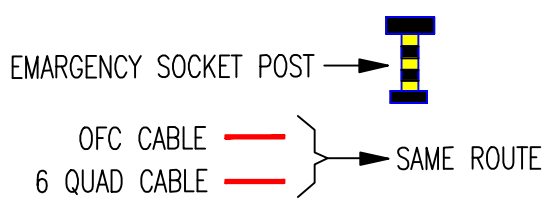
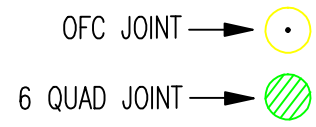
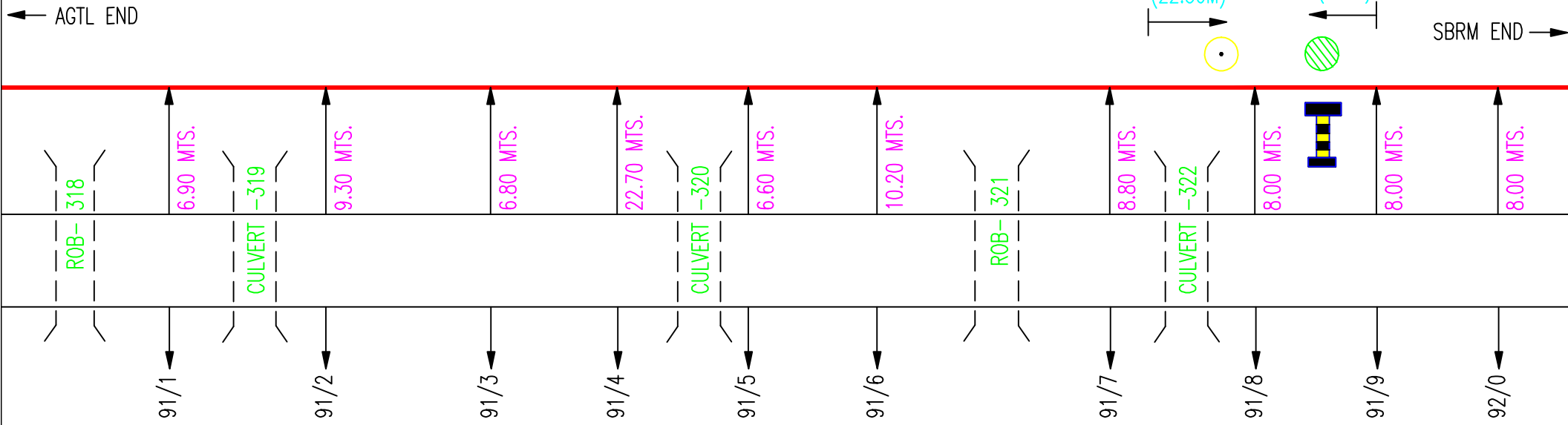

JOLAIBARI STATION

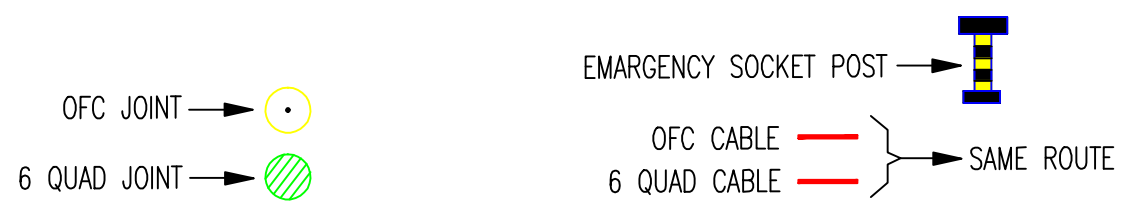
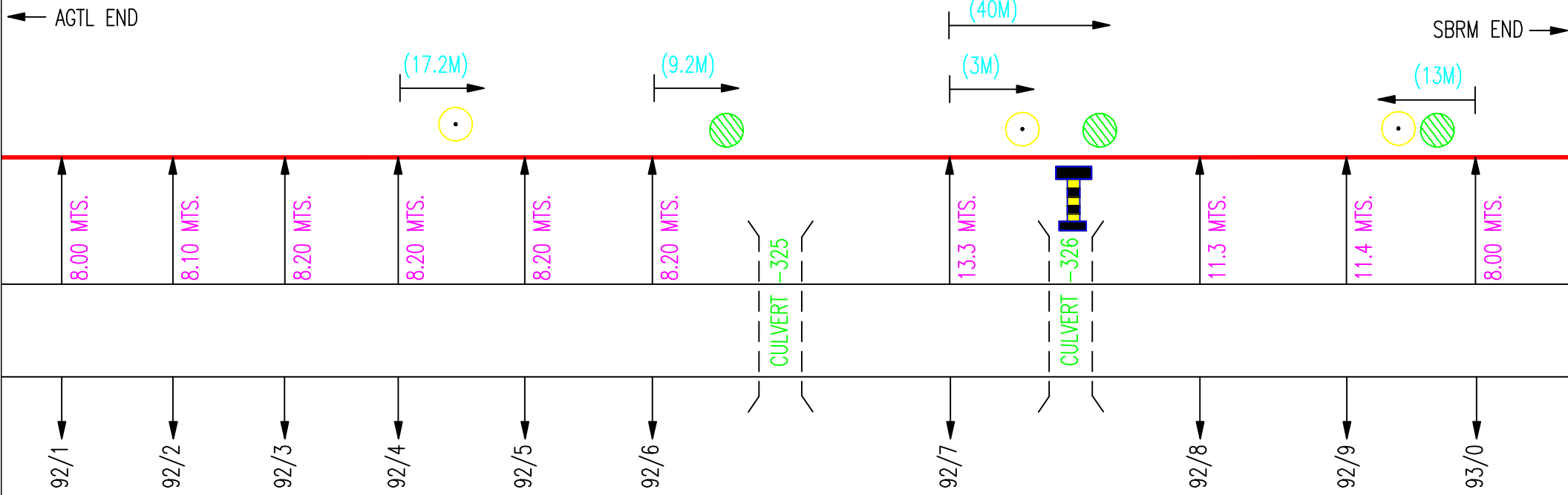

JOLAIBARI STATION

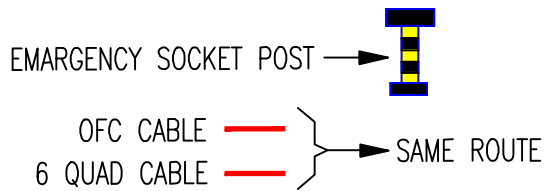
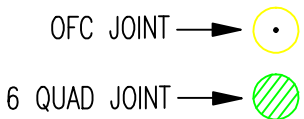
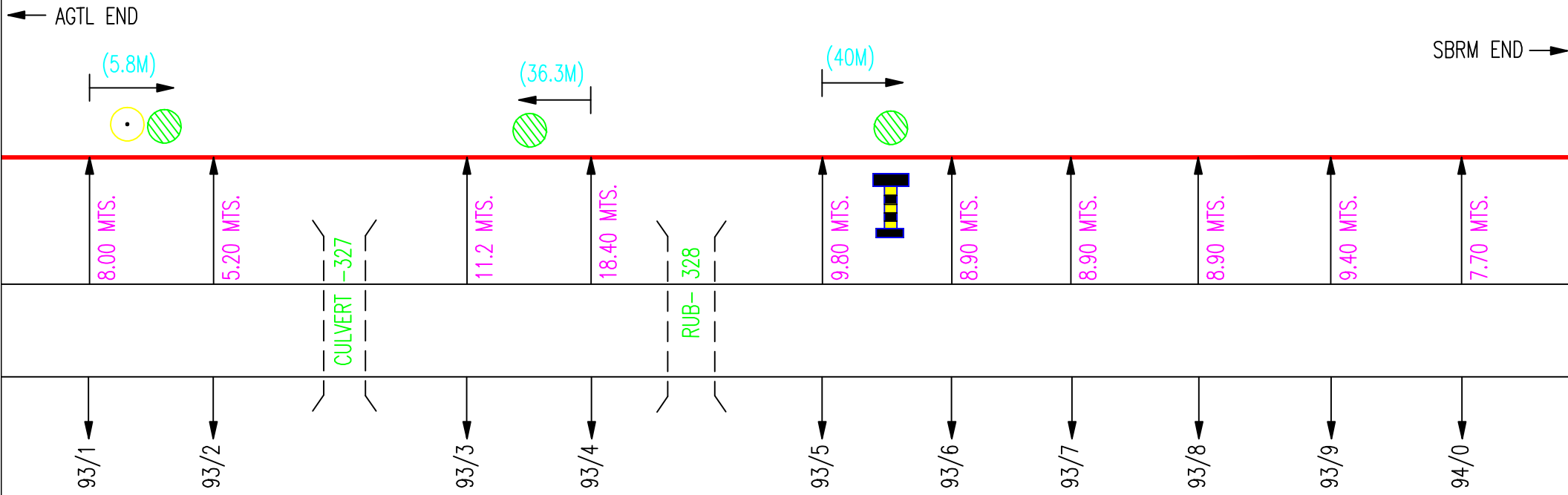

JOLAIBARI STATION

← AGTL END
SBRM END →

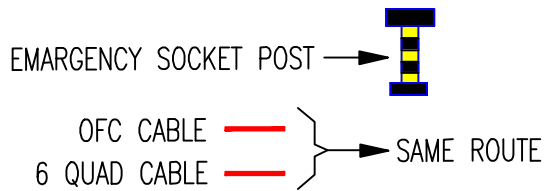
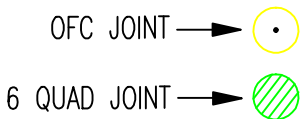
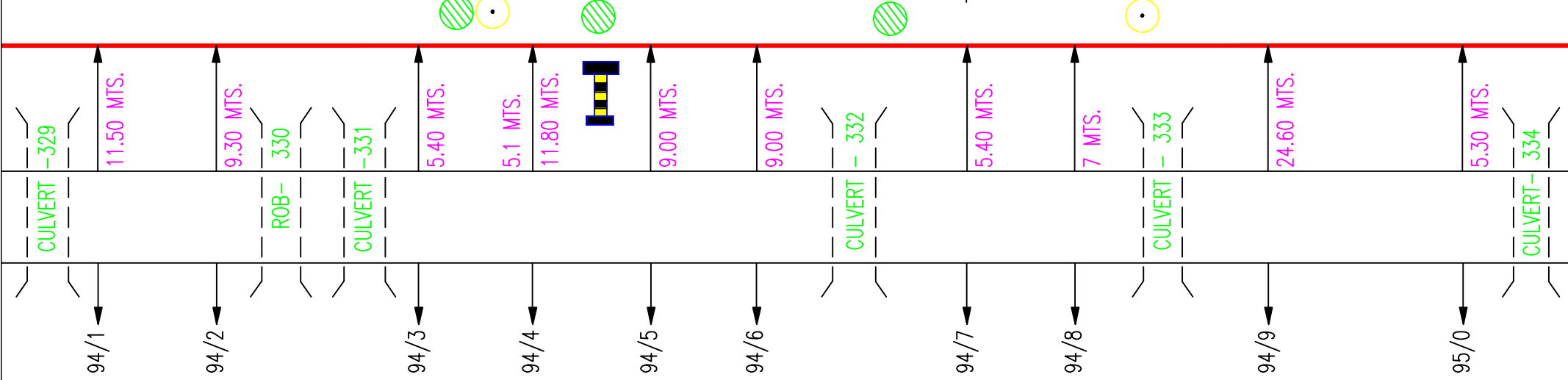

JOLAIBARI STATION

← AGTL END

SBRM END →

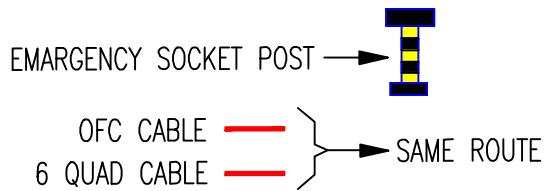
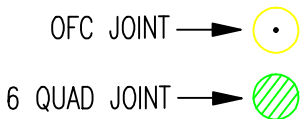
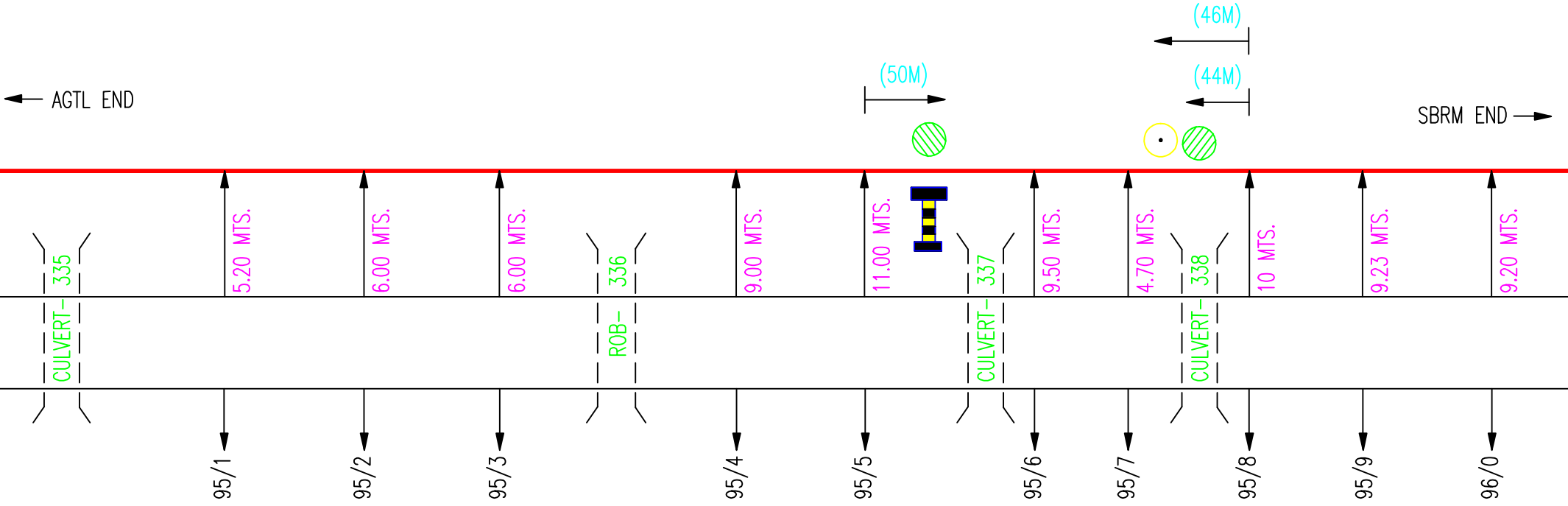

JOLAIBARI STATION

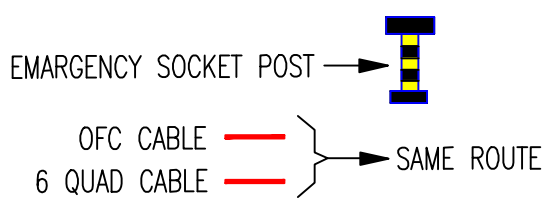
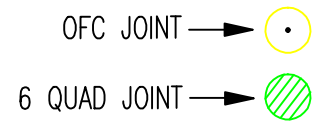
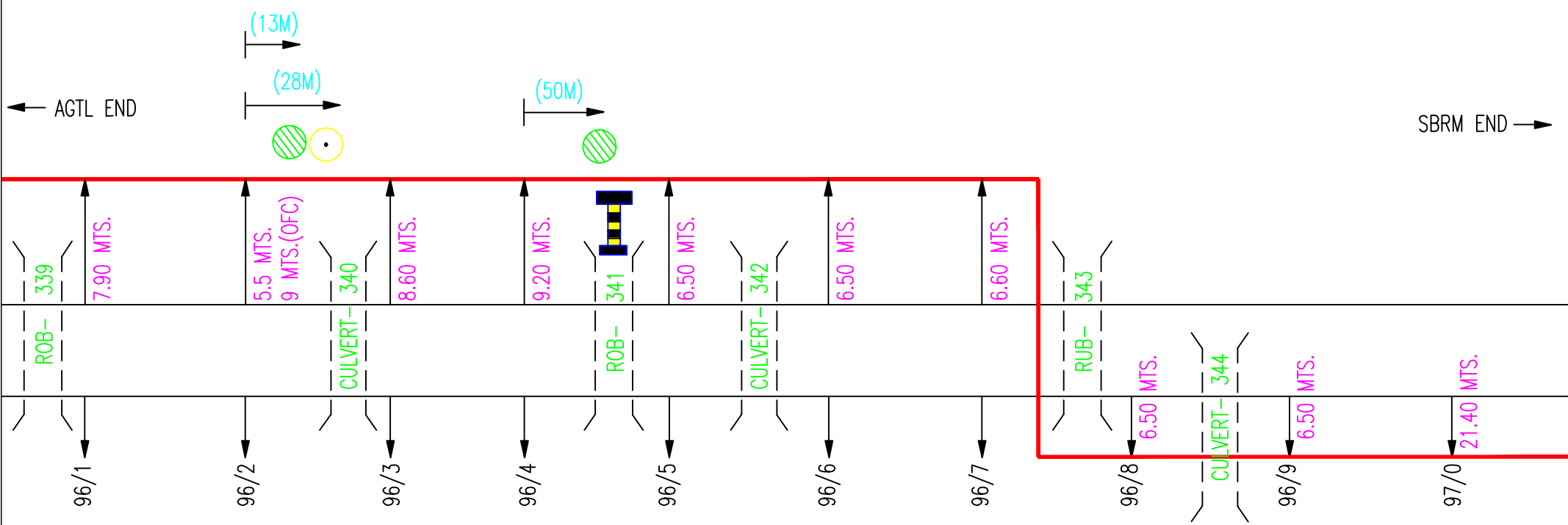

JOLAIBARI STATION

← AGTL END
SBRM END →

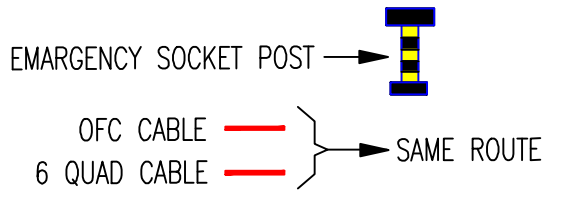
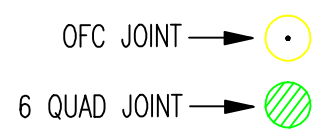
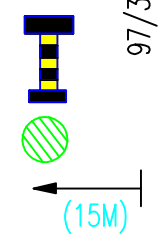
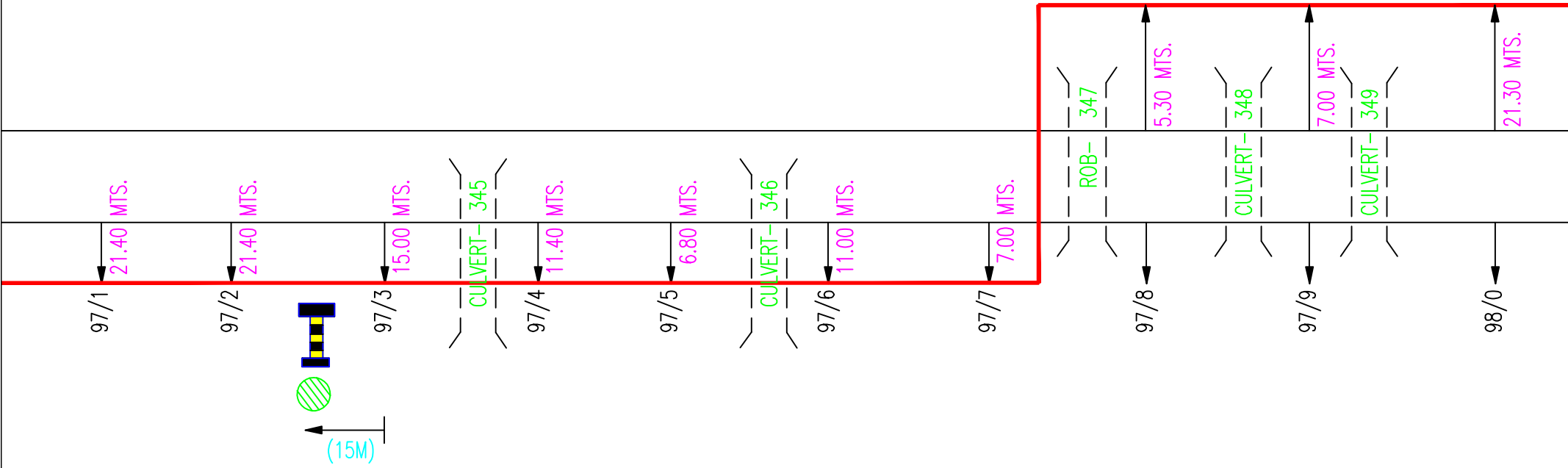

JOLAIBARI STATION

← AGTL END

SBRM END →

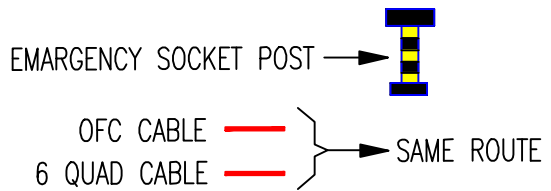
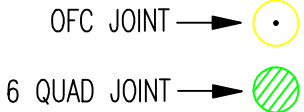
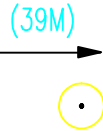
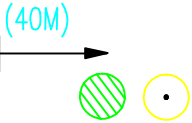
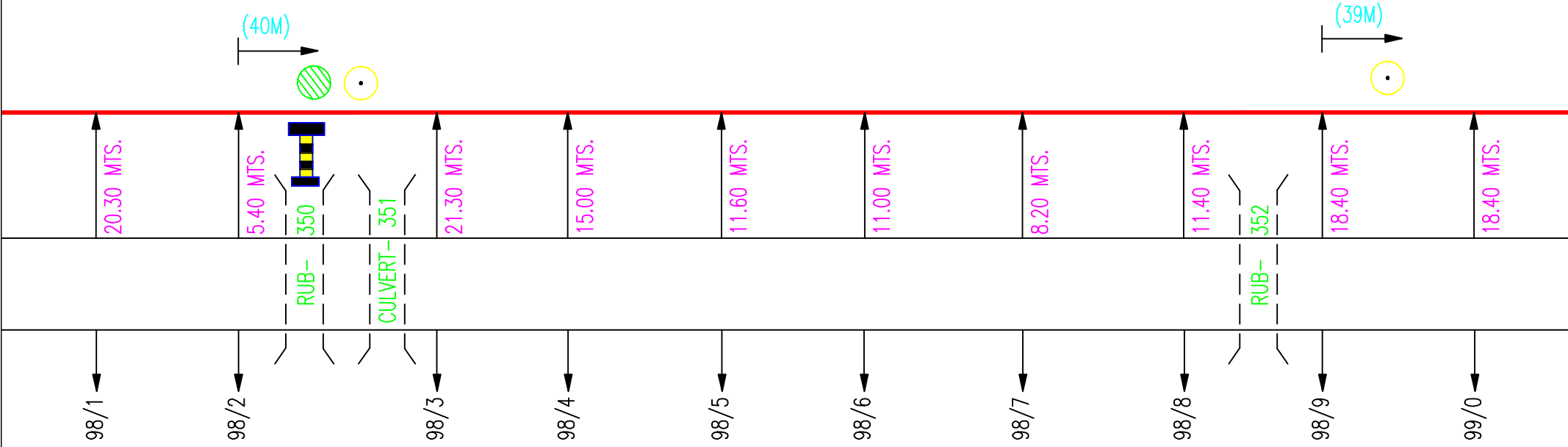

JOLAIBARI STATION

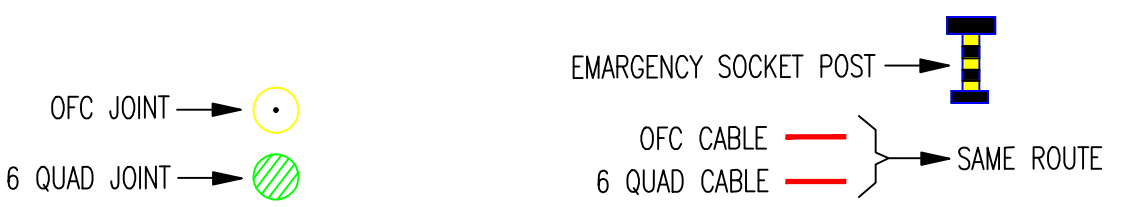
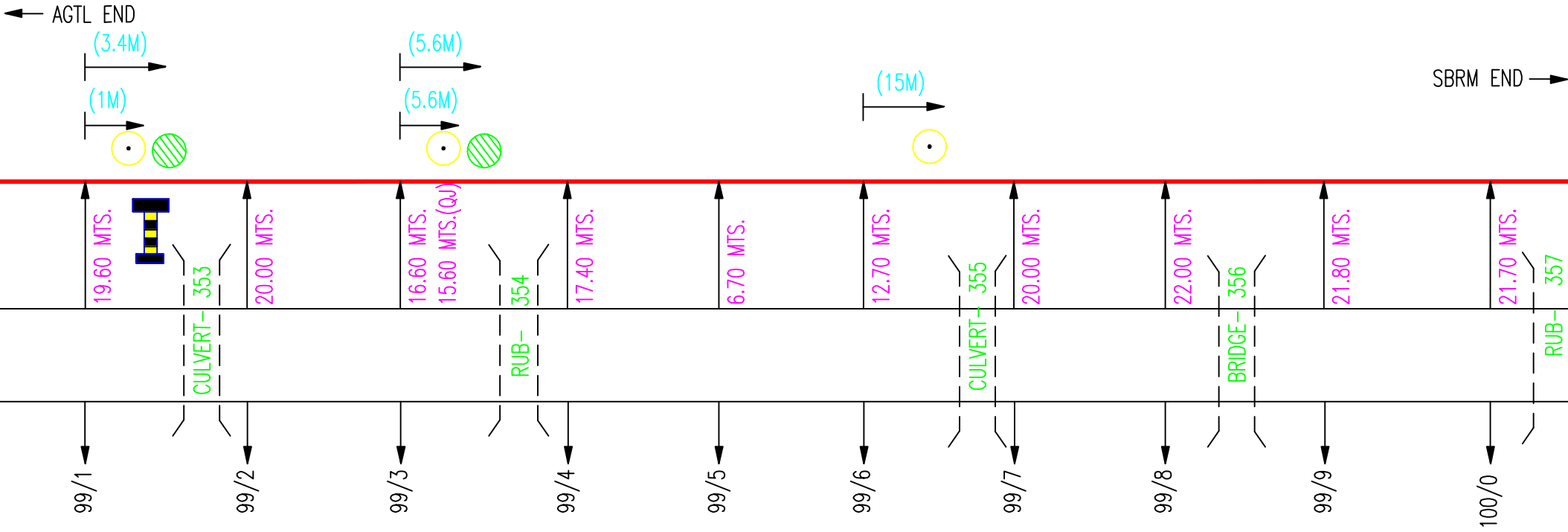

JOLAIBARI STATION

← AGTL END

SBRM END →

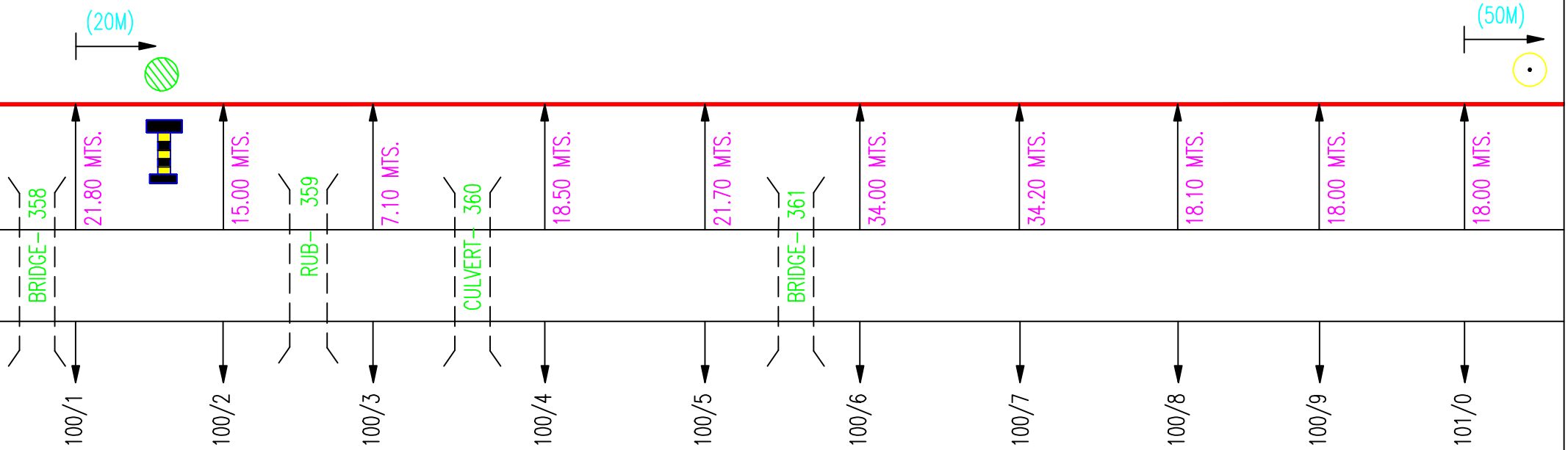

OFC JOINT →

6 QUAD JOINT →

EMERGENCY SOCKET POST →

OFC CABLE } SAME ROUTE

6 QUAD CABLE }

JOLAIBARI STATION

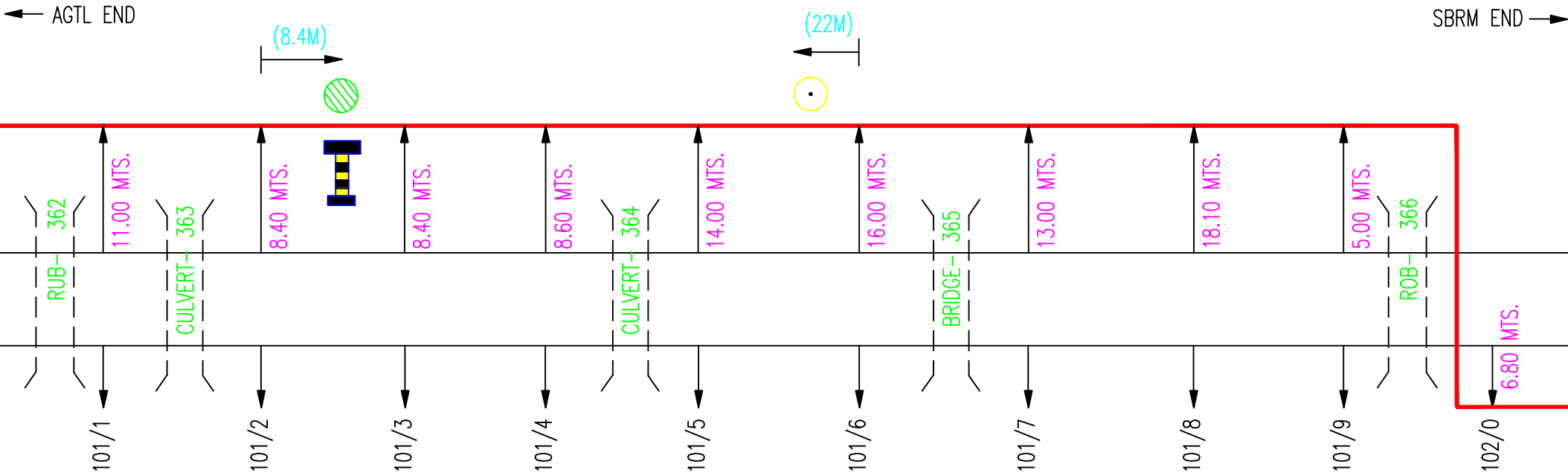

(8.4M)

(22M)

OFC JOINT →

6 QUAD JOINT →

EMARGENCY SOCKET POST →

OFC CABLE } SAME ROUTE

6 QUAD CABLE }

JOLAIBARI STATION

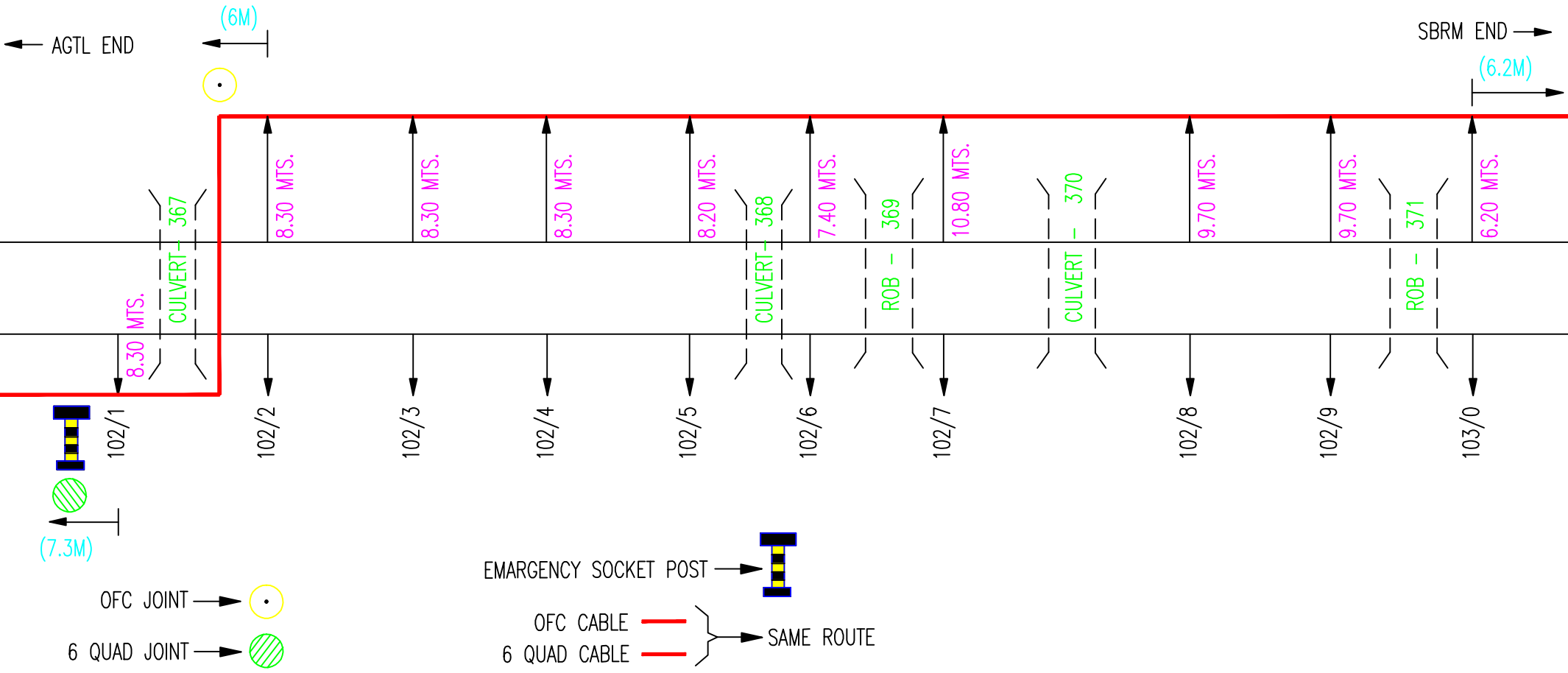

JOLAIBARI STATION

← AGTL END SBRM END →

