

SEKERKOTE (^D' CLASS)

UP →



BISHALGARH ('B' CLASS/STD.II(R)/EI)

(KM.-196.793 FROM CL OF BARAIGRAM STN.)

DN ← → UP

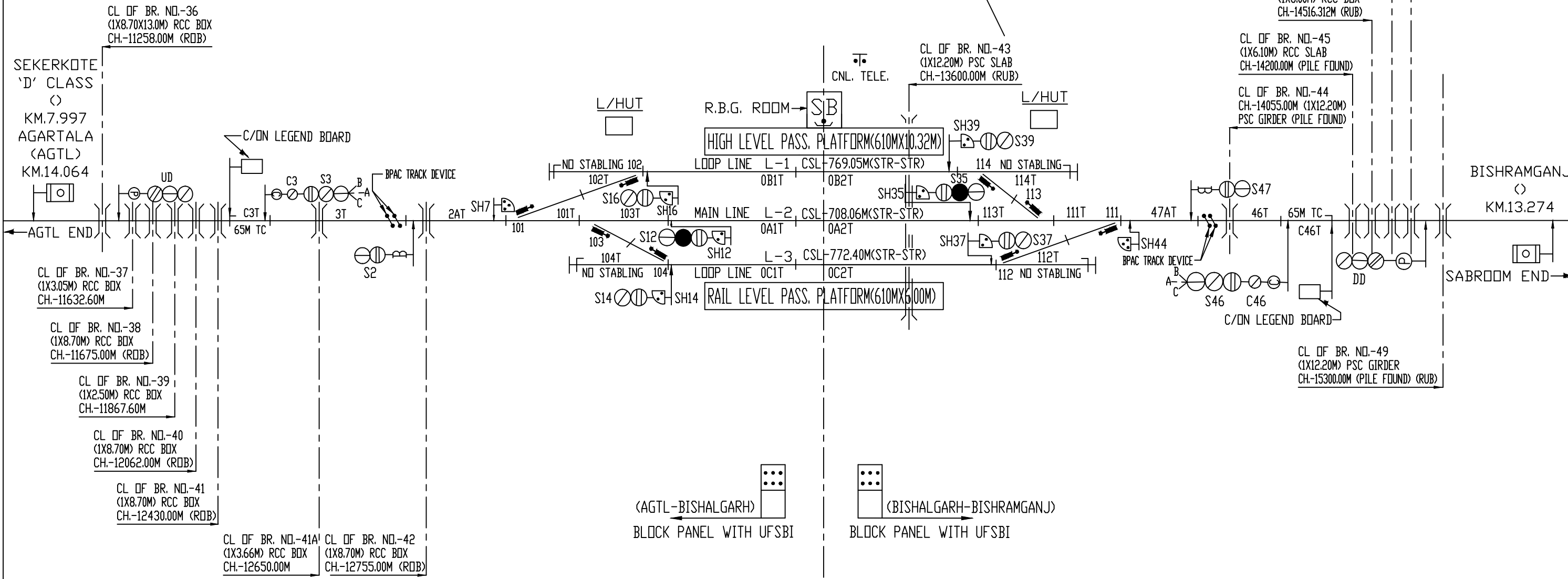

(AGTL-BISHALGARH) BLOCK PANEL WITH UFSBI
 (BISHALGARH-BISHRAMGANJ) BLOCK PANEL WITH UFSBI

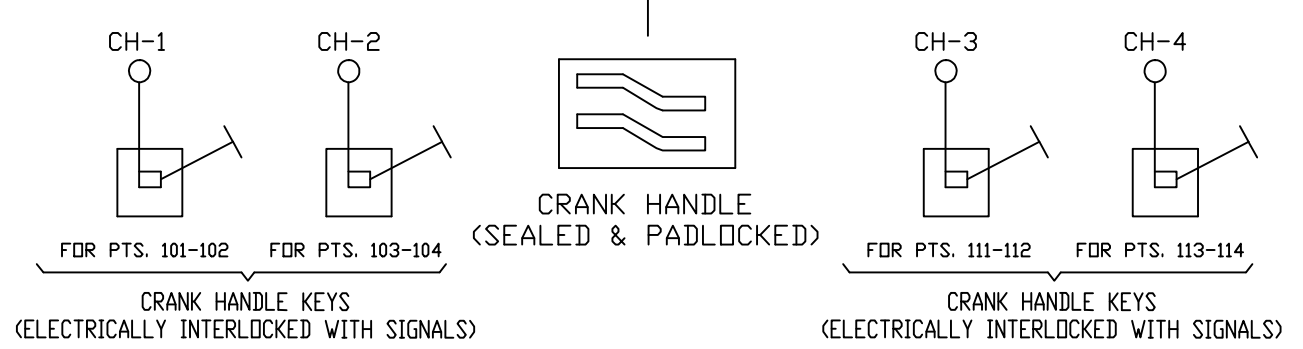

BISHRAMGANJ ('B' CLASS/STD.II(R)/EI)

(KM.-210.067 FROM CL OF BARAIGRAM STN.)

DN ← → UP

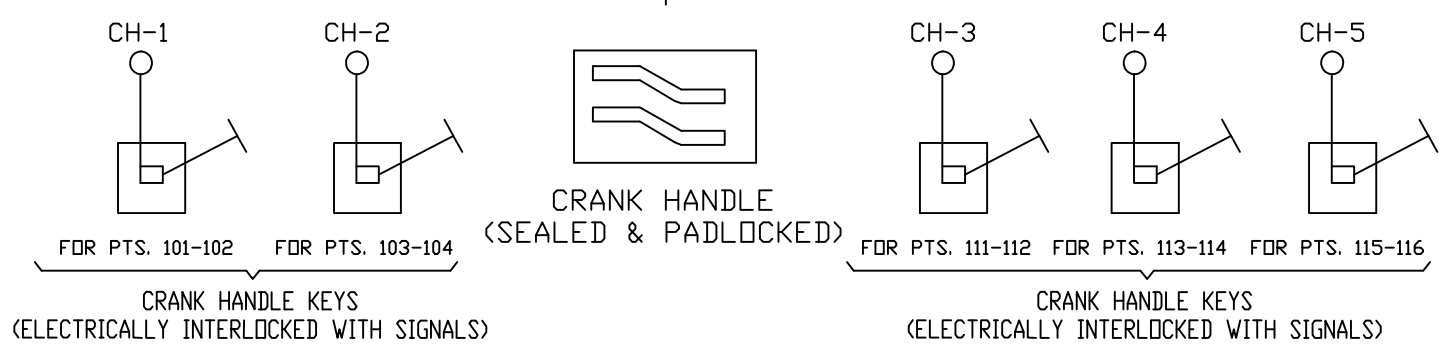
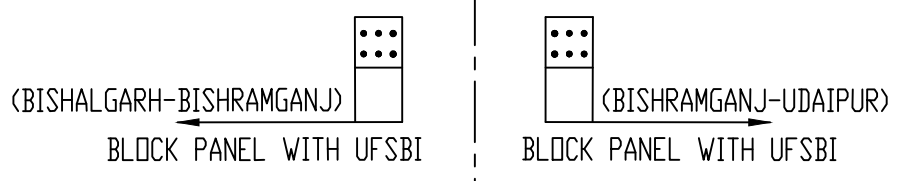
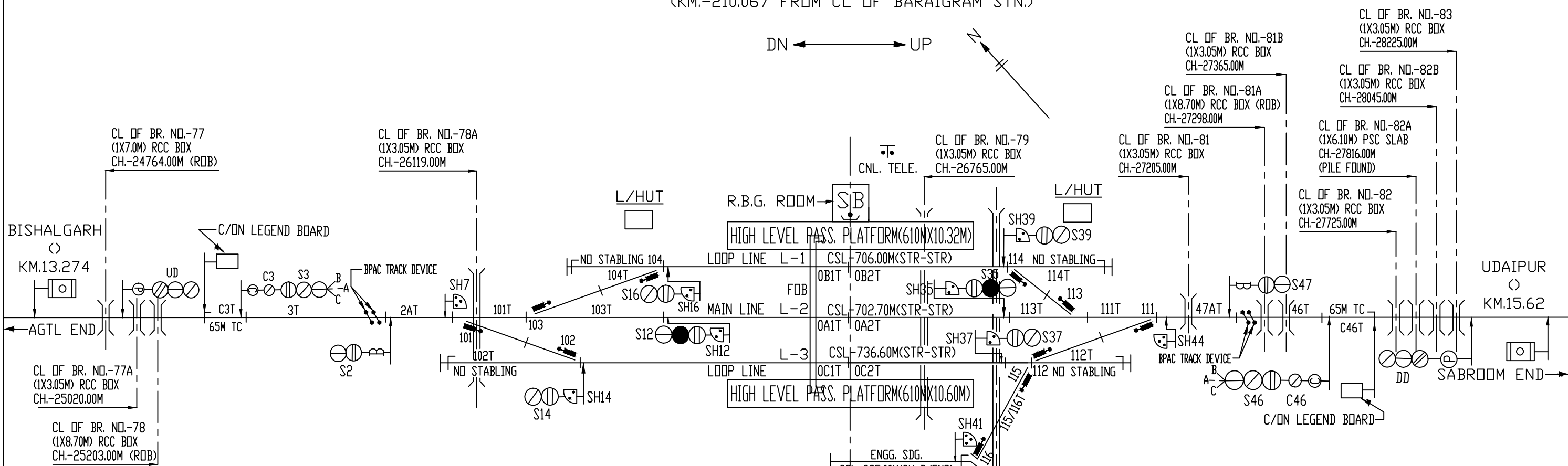

UDAIPUR ('B' CLASS/STD.II(R)/EI)

(KM.-225.687 FROM CL OF BARAIGRAM STN.)

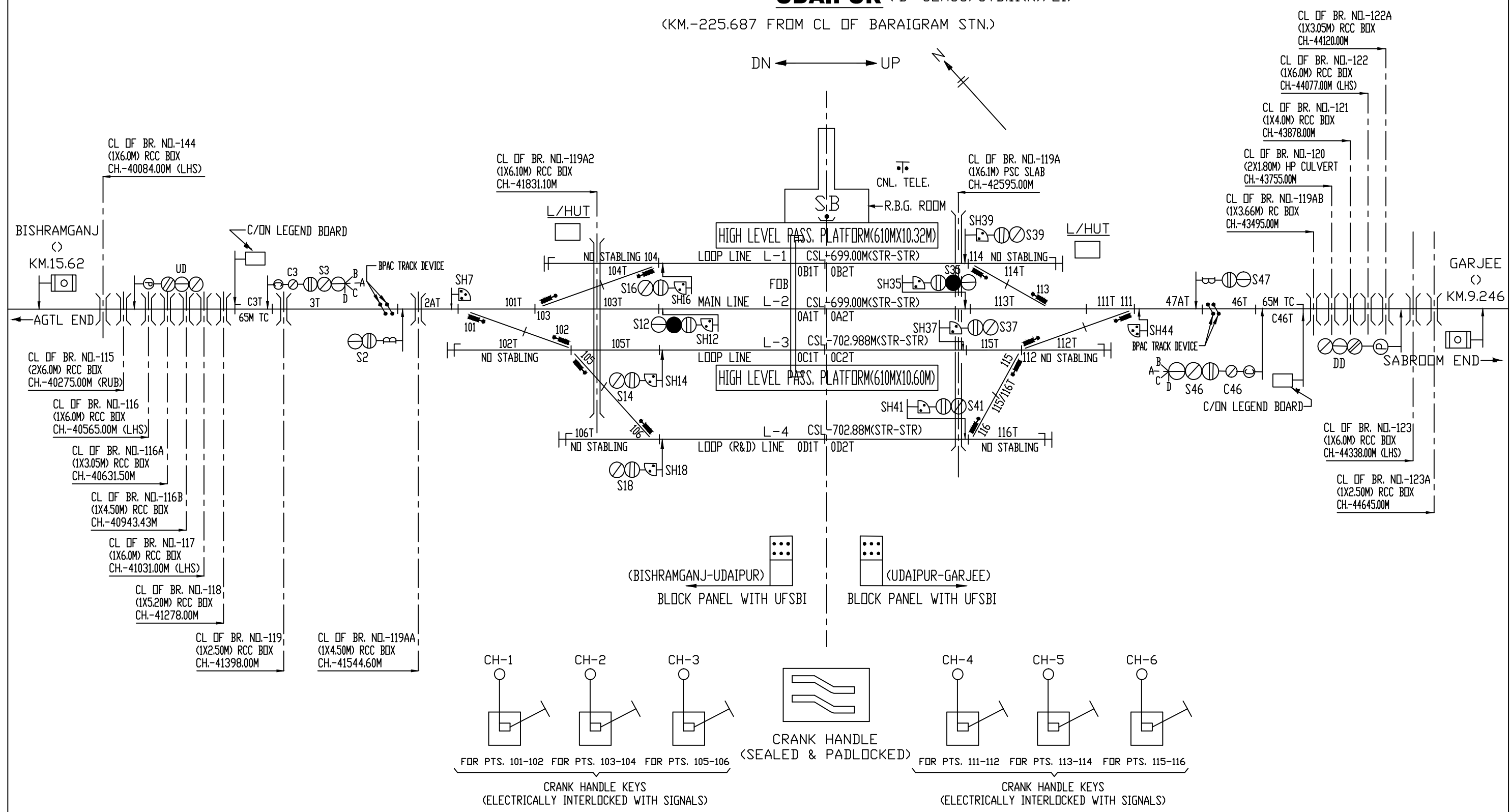

GARJEE ('B' CLASS/STD.II(R)/EI)

(KM.-234.933 FROM CL OF BARAIGRAM STN.)

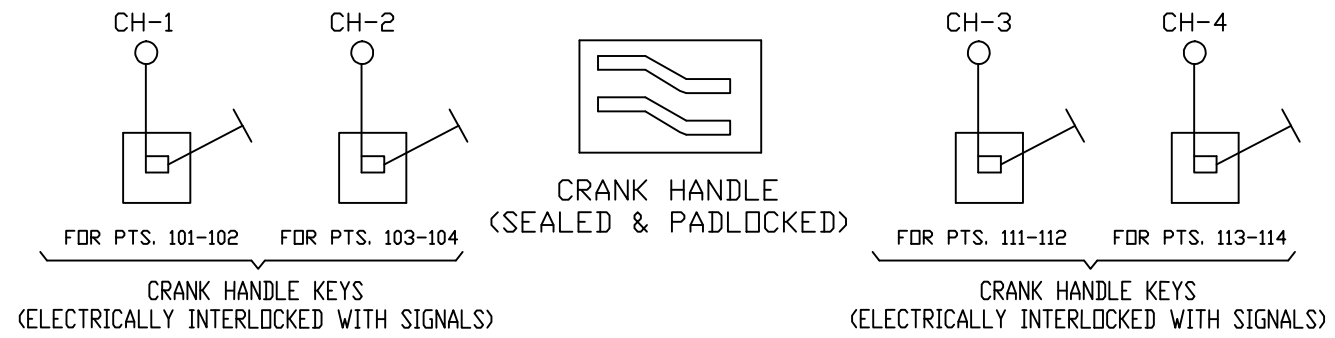
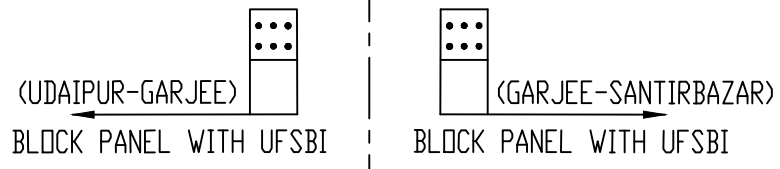
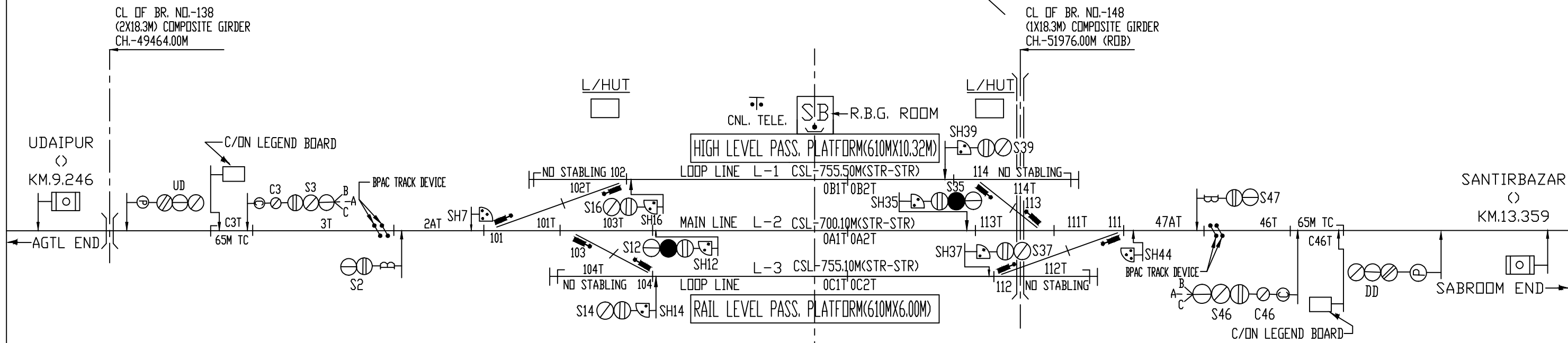
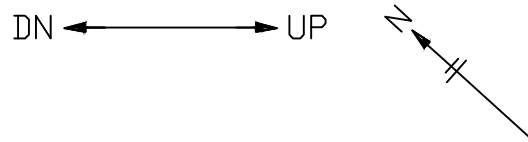

SANTIRBAZAR ('B' CLASS/STD.II(R)/EI)

(KM.-248.292 FROM CL OF BARAIGRAM STN.)

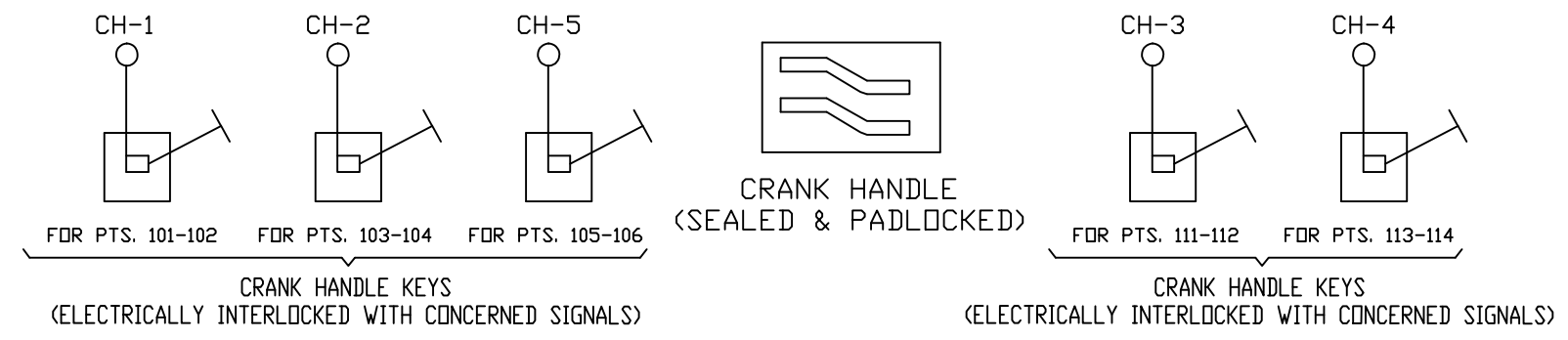
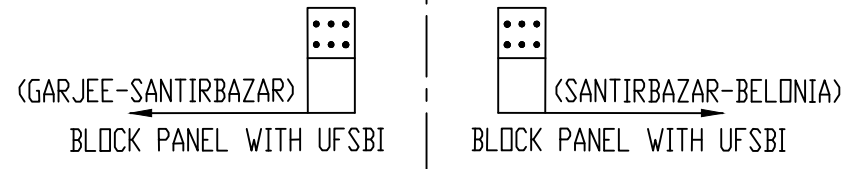
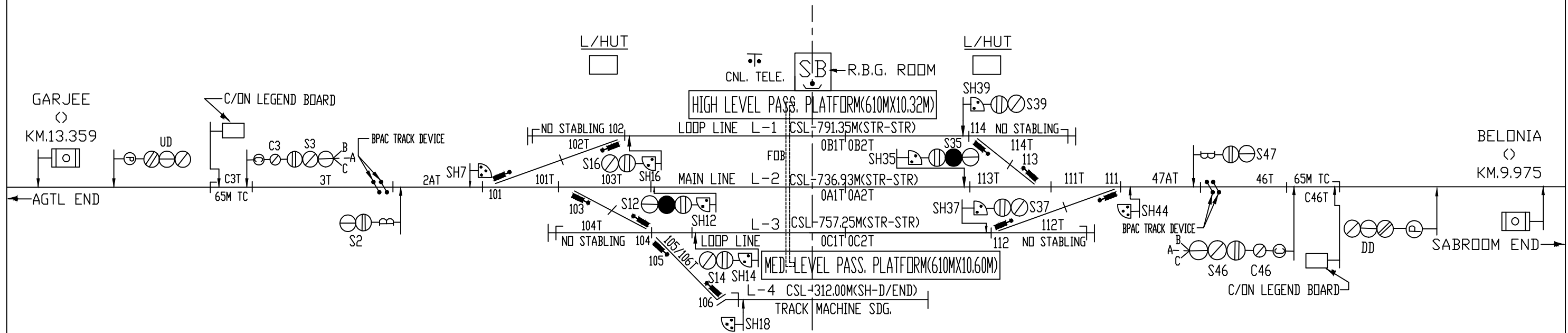
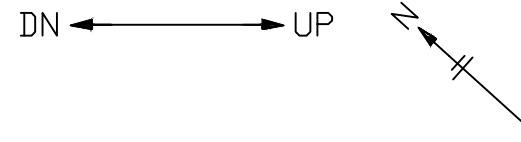

BELONIA ('B' CLASS/STD.II(R)/EI)

(KM.-258.267 FROM CL OF BARAIGRAM STN.)
(KM.-75.539 FROM CL OF AGARTALA STN.)

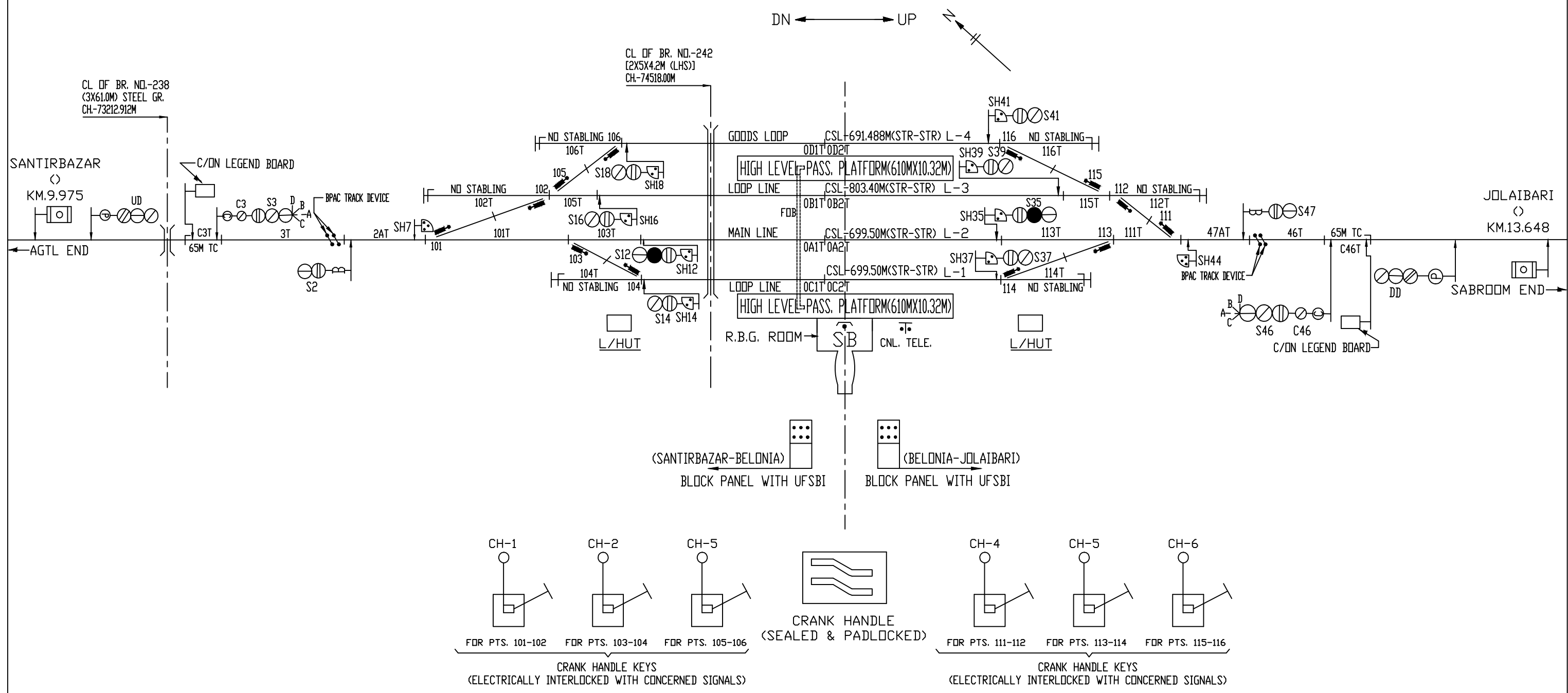

JOLAIBARI ('B' CLASS/STD.II(R)/EI)

(KM.-271.915 FROM CL OF BARAIGRAM STN.)

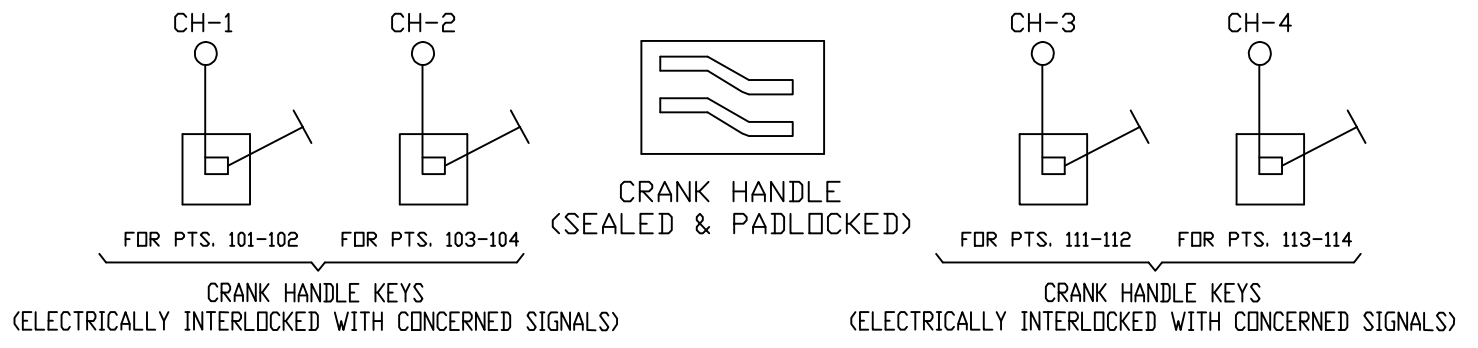
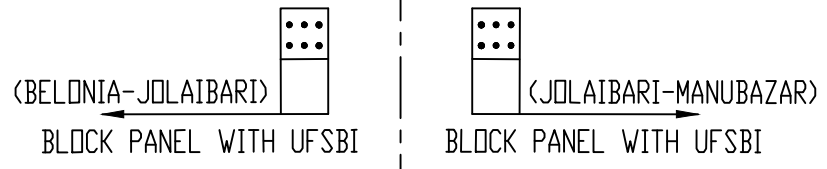
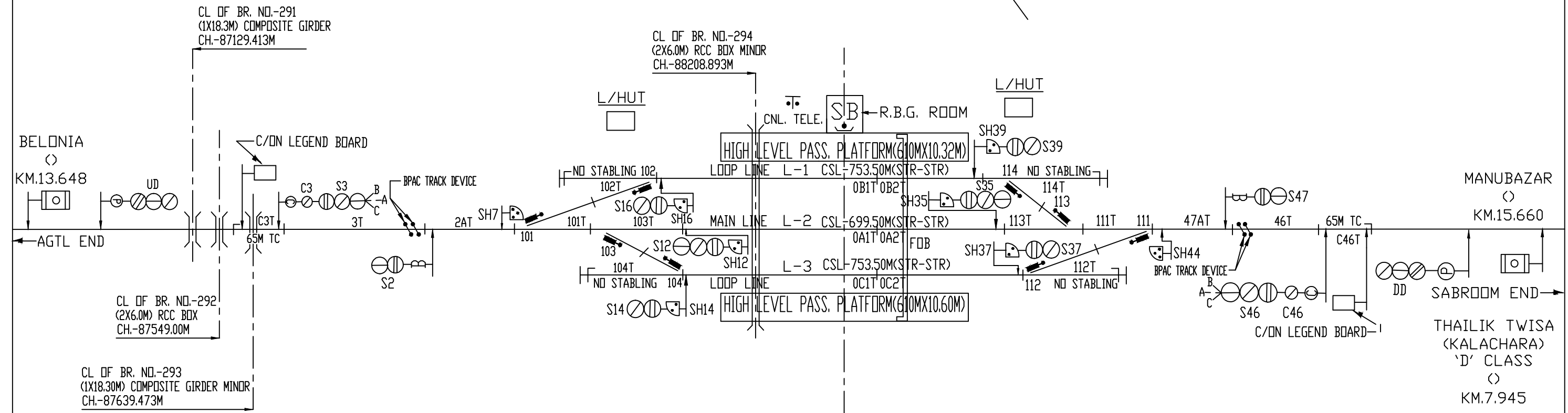
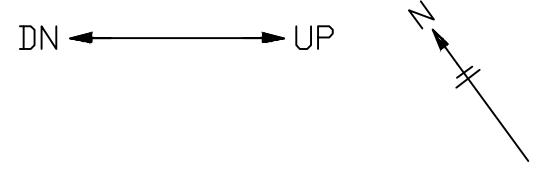

THAILIK TWISA (D' CLASS)

DN ← → UP

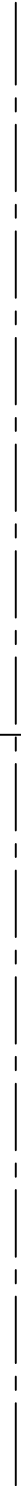

MANUBAZAR ('B' CLASS/STD.II(R)/EI)

(KM.-287.575 FROM CL OF BARAIGRAM STN.)

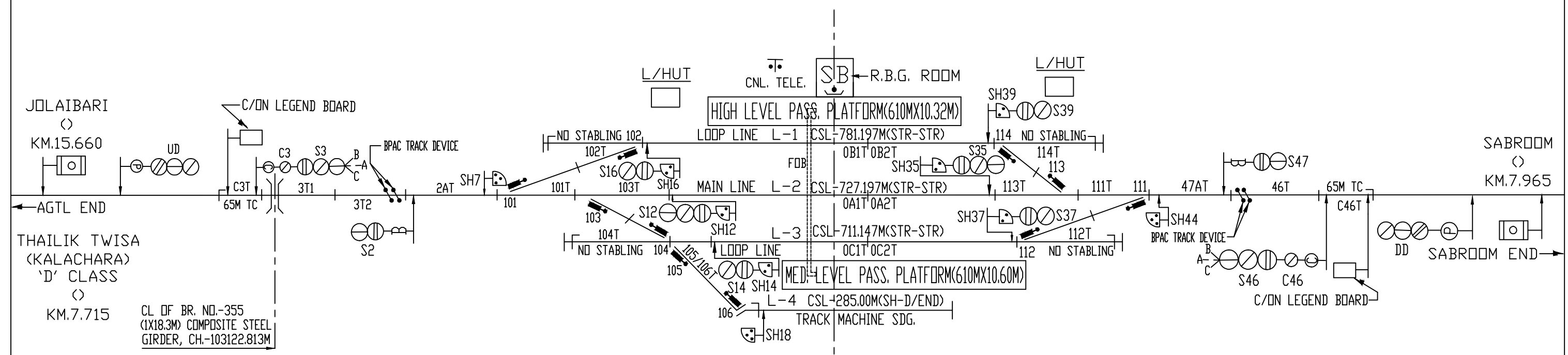
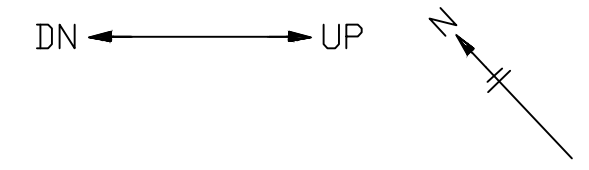

JOLAIBARI
(\circ)
KM.15.660

AGTL END

THAILIK TWISA
(KALACHARA)
'D' CLASS
(\circ)
KM.7.715

CL. OF BR. NO.-355
(1X18.3M) COMPOSITE STEEL
GIRDER, CH.-103122.813M

SABROOM
(\circ)
KM.7.965

SABROOM END

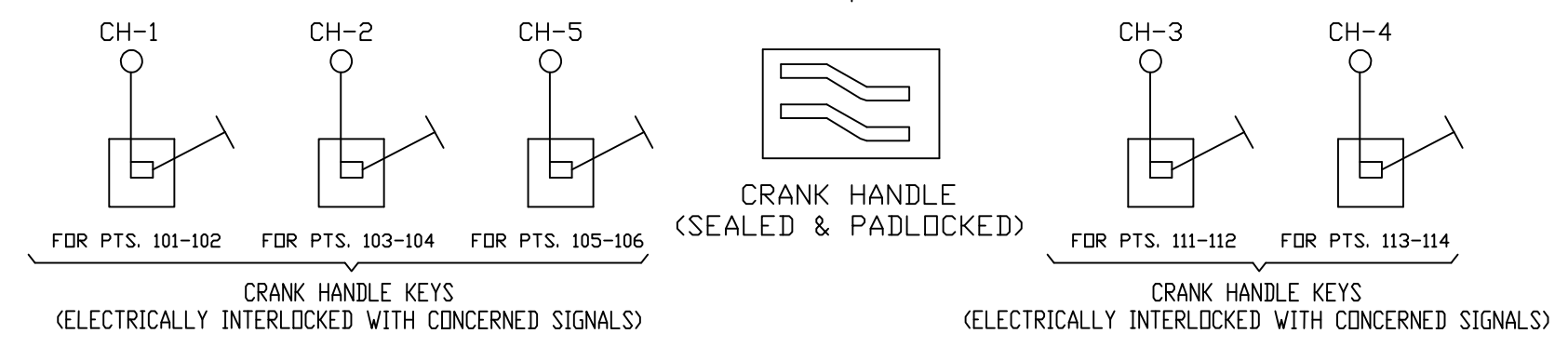
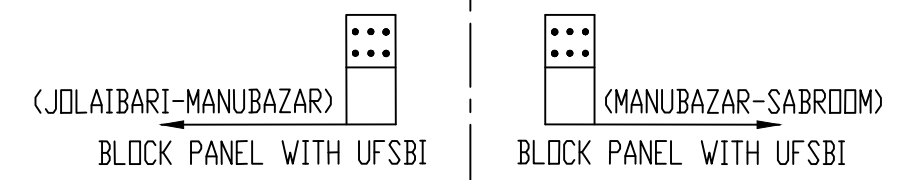

SABROOM ('B' CLASS/STD.I(R)/EI/TERMINAL STN./PH-I)

(CH.-112906.50 FROM CL OF AGARTALA STN.)

