

# MARDANGA ('B' CLASS/STD.-II(R)/SSI)

KM.-103.070 FROM NMX

UP →



LEGEND BOARD  
LEGEND:- "DRAW CLOSE TO HOME SIG. IF IT IS AT ON."

{ CL OF BR. NO.126(3X45.7M)  
STEEL GIRDER, AT CH.102026.23M

NEW COOCHBEHAR (NCB)  
KM-13.464

CONT. TELE.

TO LC GATE NO.CA-5

RBG ROOM

TO SM

GOOMTY

M. L. PASSENGER PLATFORM

TUFANGANJ  
( )  
KM-10.922  
JPZ END

NCB END

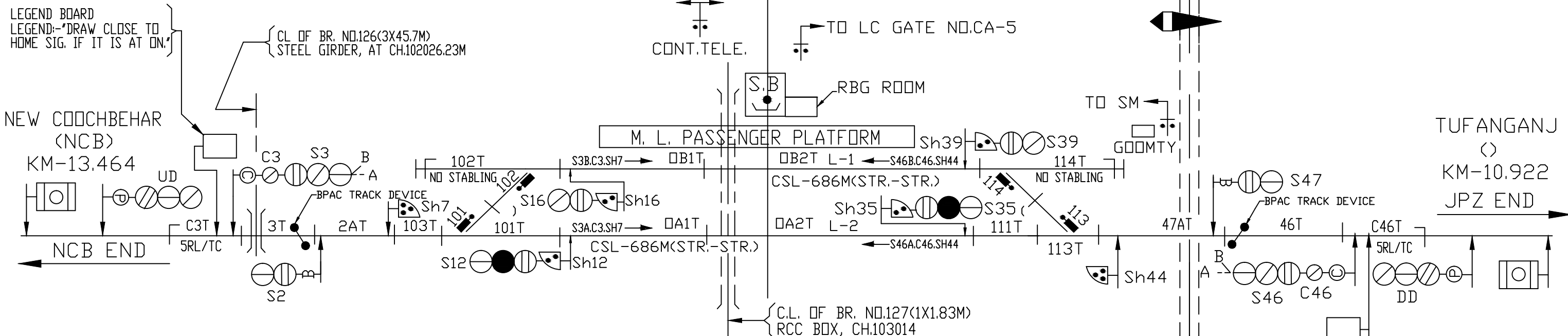

{ C.L. OF BR. NO.127(1X1.83M)  
RCC BOX, CH.103014

LEGEND BOARD  
LEGEND:- "DRAW CLOSE TO HOME SIG. IF IT IS AT ON."

(NCB-MARDANGA)  
BLOCK PANEL WITH UFSBI  
(SINGLE LINE)

(MARDANGA-TUFANGANJ)  
BLOCK INST.  
(TOKENLESS)

GATE CONTROL BUTTON  
FOR GATE NO. CA-5

AT GATE GOOMTY

AT GATE GOOMTY

CH-1

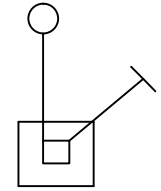

FOR PTS. NO-(101-102)

CRANK HANDLE KEYS  
INTERLOCKED WITH SIGNALS

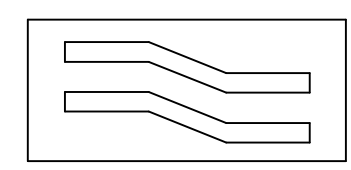

CRANK HANDLE  
(SEALED & PADLOCKED)

CH-4

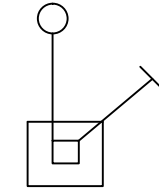

FOR PTS. NO-(113-114)

CRANK HANDLE KEYS  
INTERLOCKED WITH SIGNALS

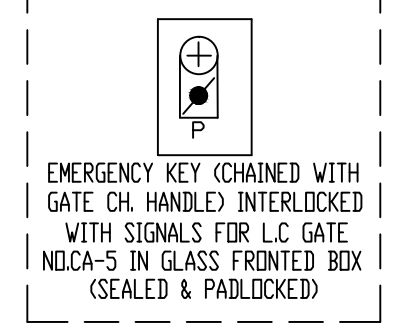
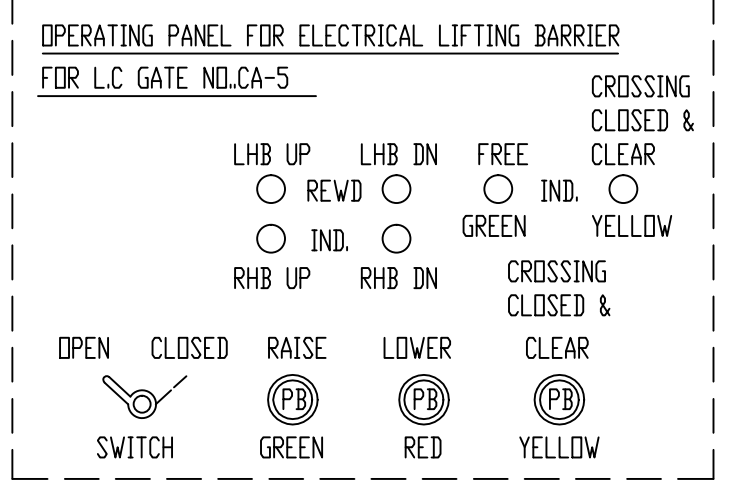

**TUFANGANJ** 'C' CLASS/STD.-II(R)/SSI

KM.-113.992 FROM NMX

UP →

CONT. TELE.

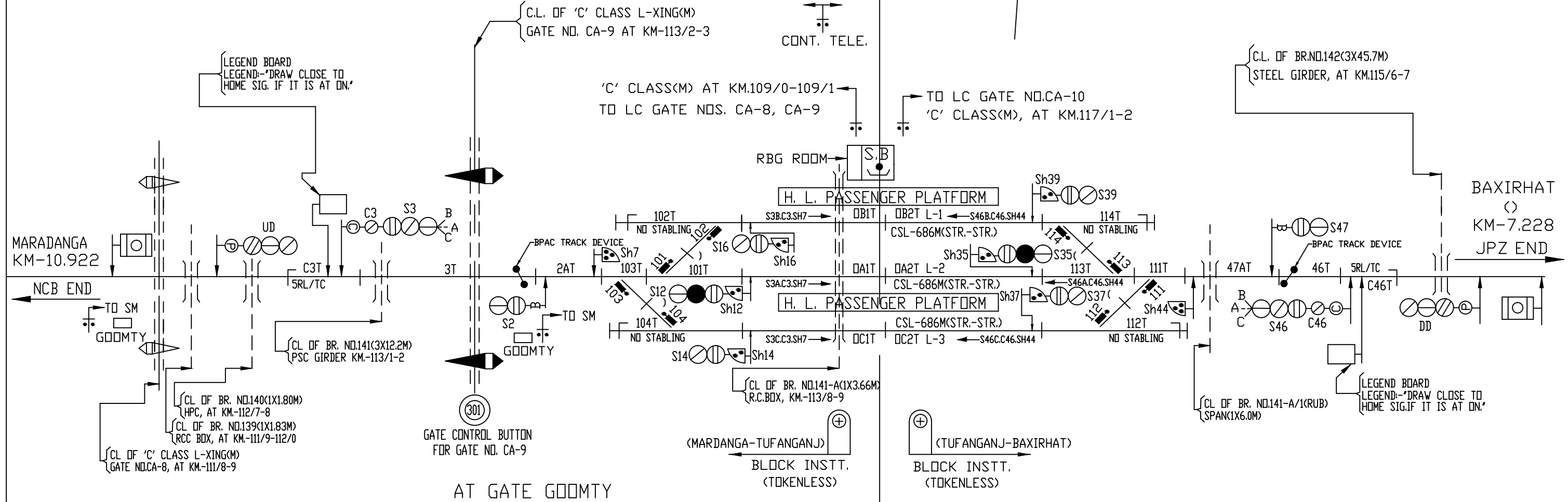

AT GATE GOOMTY

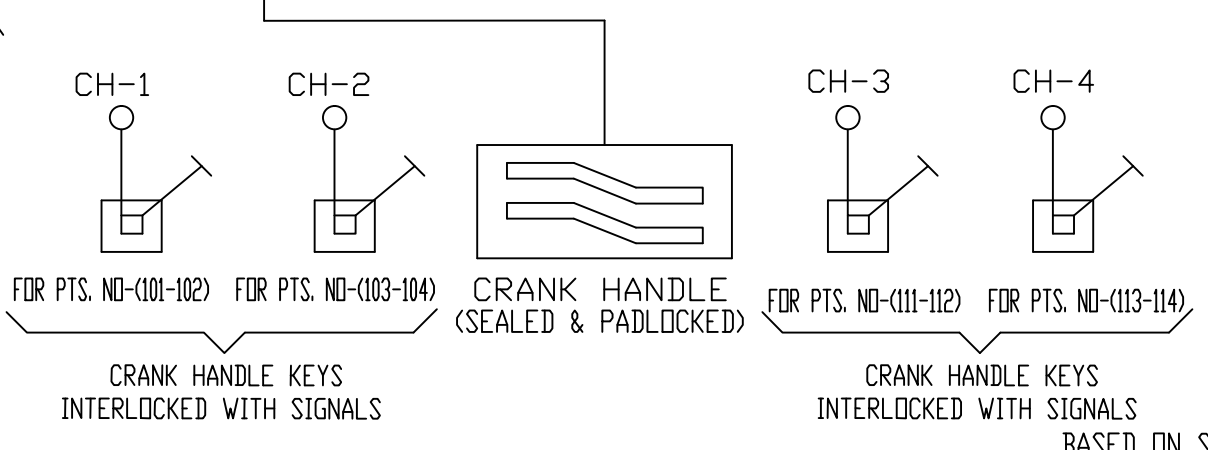
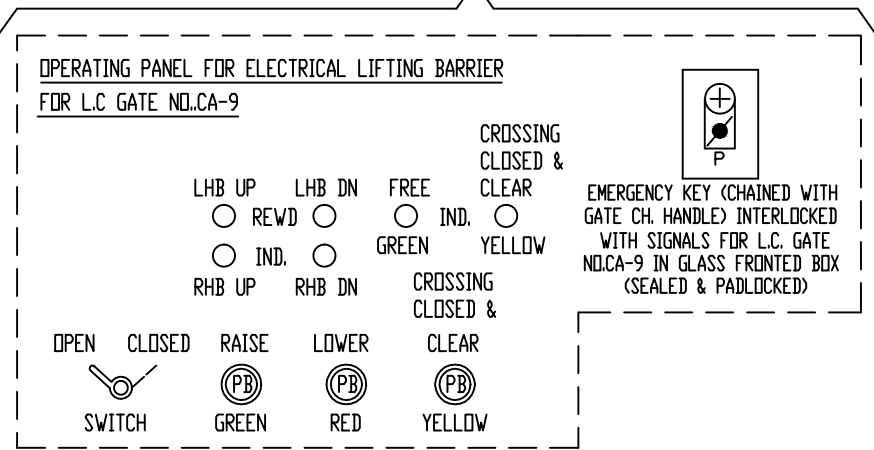

BASED ON SIP NO. SG (SI) 2085, ALT.-D

# BAXIRHAT ('B' CLASS/STD.-II(R)/SSI)

KM.-121.22 FROM NMX

UP →

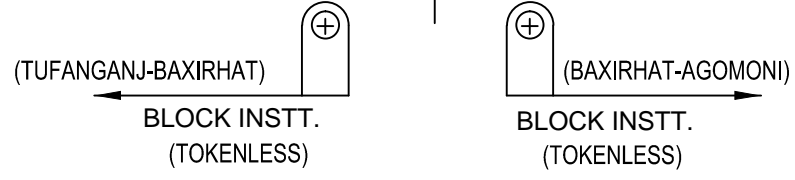
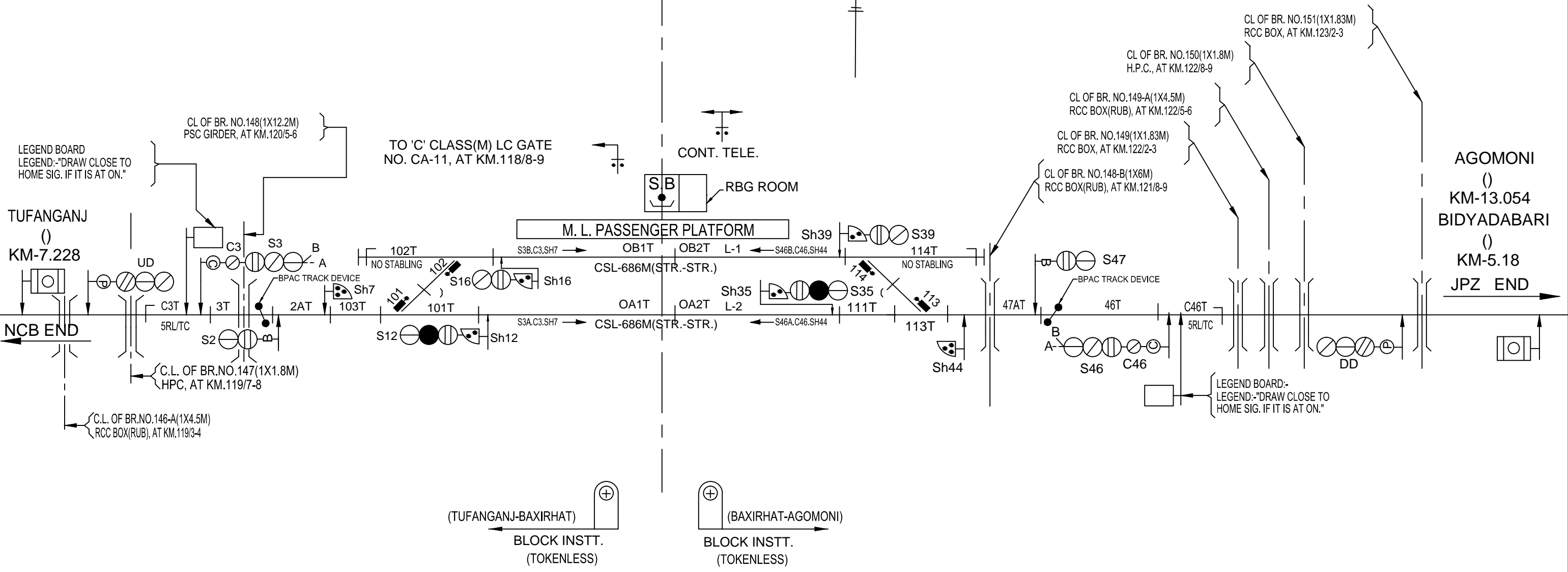

BIDYABARI ('D' CLASS)

UP →

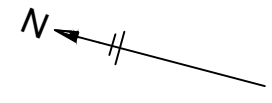

CL OF STN. BLDG.  
AT CH. 126/400  
(FROM NMX)

BAXIRHAT  
'B' CLASS  
KM-5.18

PLATFORM 170X7M

S.B

AGOMONI  
'B' CLASS  
KM-7.90

**AGOMONI** ('B' CLASS/STD.-II(R)/SSI)

KM.-134.274 FROM NMX

UP →

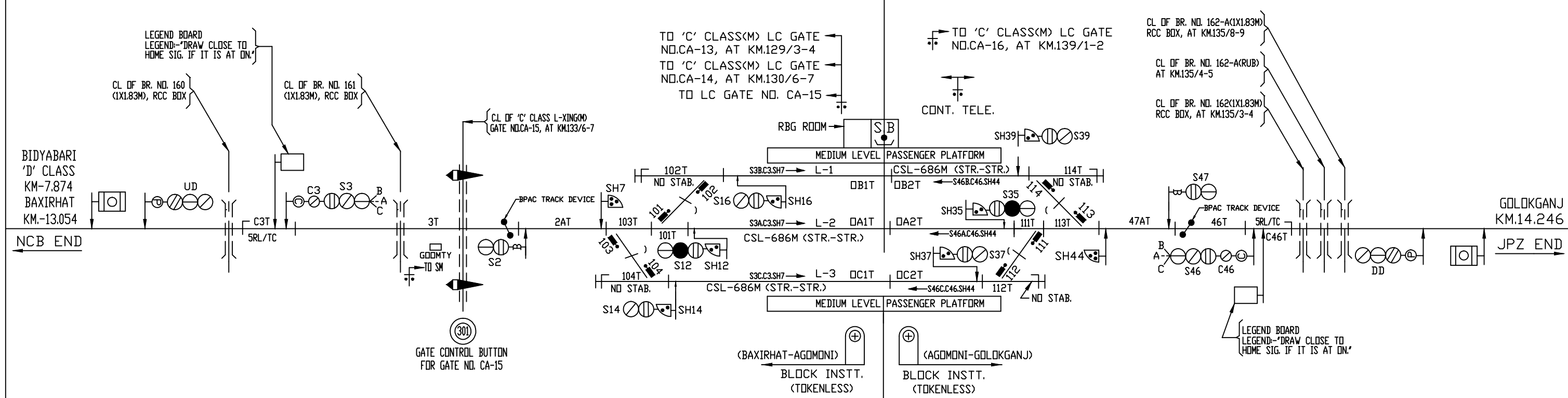
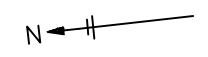

AT GATE GOOMTY

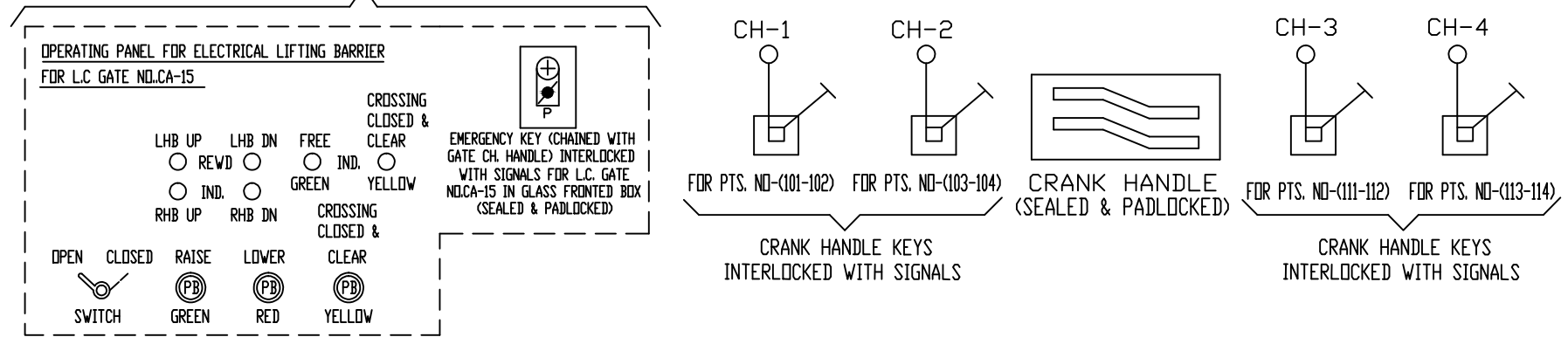

BASED ON SIP NO. SG (SI) 2093, ALT.-D